

SYLVANIA

Owner's Manual

SSL2006

20 INCH LCD TELEVISION
(Tilt Stand Type)

FEATURES

- **MTS/SAP Tuner**
- **181 Channel Selection-** All VHF/UHF channels plus up to 125 cable channels.
- **PLL Frequency Synthesized Tuning-** Provides free and easy channel selection and lets you tune directly to any channel using the channel number buttons on the remote control.
- **Sleep Timer**
- **Closed Caption Decoder**
- **Auto Shut Off Function-** If there is no signal input from the antenna terminal and no user operation for 15 minutes, the TV will turn itself off automatically.
- **V-CHIP-** Enables parents to prevent their children from watching inappropriate material on TV.
- **Full-Function Remote Control**
- **On-Screen Function Display**
- **S-VIDEO Input-** Allows you to get better picture detail and clarity.
- **Component Input**

PRECAUTIONS

- Place your TV in a room with adequate ventilation.
- Keep your TV set away from sources of direct heat, such as heat registers or direct sunlight.
- Do not place your TV on soft surfaces, such as rugs or blankets.
- Leave enough room for air to circulate around the bottom, top and back of the set.

The serial number of this product may be found on the back of the TV. No others have the same serial number as yours. You should record the number and other vital information here and retain this book as a permanent record of your purchase to aid identification in case of theft.

Date of Purchase	Dealer Phone No.
Dealer Purchase from	Model No.
Dealer Address	Serial No.

IF YOU NEED ADDITIONAL ASSISTANCE WITH SET-UP OR OPERATING AFTER READING OWNER'S MANUAL, PLEASE CALL TOLL FREE 1-800-968-3429 OR VISIT OUR WEB SITE AT <http://www.SylvaniaConsumerElectronics.com>

SYLVANIA LIMITED WARRANTY

FUNAI CORP. will repair this product, free of charge in the USA in the event of defect in materials or workmanship as follows:

DURATION: This warranty is extended only to the original retail purchaser. A purchase receipt or other proof of original retail purchase will be required together with the product to obtain service under this warranty.

PARTS: FUNAI CORP. will provide parts to replace defective parts without charge for one (1) year from the date of original retail purchase. Certain parts and LCD image burn-in are not covered under this warranty.

LABOR: FUNAI CORP. will provide the labor without charge for a period of ninety (90) days from the date of original retail purchase.

LIMITS AND EXCLUSIONS: This warranty is extended only to the original retail purchaser. A purchase receipt or other proof of original retail purchase will be required together with the product to obtain service under this warranty. This warranty shall not be extended to any other person or transferee. This warranty is void and of no effect if any serial numbers on the product are altered, replaced, defaced, missing or if service was attempted by an unauthorized service center. This limited warranty does not apply to any product not purchased and used in the United States.

This warranty only covers failures due to defects in material or workmanship which occurs during normal use. It does not cover damage which occurs in shipment, or failures which are caused by repairs, alterations or product not supplied by FUNAI CORP., or damage which results from accident, misuse, abuse, mishandling, misapplication, alteration, faulty installation, improper maintenance, commercial use such as hotel, rental or office use of this product or damage which results from fire, flood, lightning or other acts of God.

THIS WARRANTY DOES NOT COVER PACKING MATERIALS, ANY ACCESSORIES (EXCEPT REMOTE CONTROL), ANY COSMETIC PARTS, COMPLETE ASSEMBLY PARTS, DEMO OR FLOOR MODELS.

FUNAI CORP. AND ITS REPRESENTATIVES OR AGENTS SHALL IN NO EVENT BE LIABLE FOR ANY GENERAL, INDIRECT OR CONSEQUENTIAL DAMAGES ARISING OUT OF OR OCCASIONED BY THE USE OF OR THE INABILITY TO USE THIS PRODUCT. THIS WARRANTY IS MADE IN LIEU OF ALL OTHER WARRANTIES, EXPRESS OR IMPLIED, AND OF ALL OTHER LIABILITIES ON THE PART OF FUNAI. ALL OTHER WARRANTIES INCLUDING THE WARRANTY OF MERCHANTABILITY AND FITNESS FOR A PARTICULAR PURPOSE, ARE HEREBY DISCLAIMED BY FUNAI AND ITS REPRESENTATIVES IN THE UNITED STATES.

ALL WARRANTY INSPECTIONS AND REPAIRS MUST BE PERFORMED BY AN AUTHORIZED SERVICE CENTER. THIS WARRANTY IS ONLY VALID WHEN THE UNIT IS CARRIED IN TO AN AUTHORIZED SERVICE CENTER.

THE PRODUCT MUST BE ACCOMPANIED BY A COPY OF THE ORIGINAL RETAIL PURCHASE RECEIPT. IF NO PROOF OF PURCHASE IS ATTACHED, THE WARRANTY WILL NOT BE HONORED AND REPAIRS COSTS WILL BE CHARGED.

IMPORTANT: THIS LIMITED WARRANTY GIVES YOU SPECIFIC LEGAL RIGHTS. YOU MAY HAVE OTHER RIGHTS THAT VARY FROM STATE TO STATE. IF, AT ANY TIME DURING THE WARRANTY PERIOD, YOU ARE UNABLE TO OBTAIN SATISFACTION WITH THE REPAIR OF THIS PRODUCT, PLEASE CONTACT FUNAI CORP.

ATTENTION: FUNAI CORP. RESERVES THE RIGHT TO MODIFY ANY DESIGN OF THIS PRODUCT WITHOUT PRIOR NOTICE.

WARRANTY STATEMENT REGARDING NON AUTHORIZED REPAIRS: To obtain warranty service, you must take the product, or deliver the product freight prepaid, in either its original packaging or packaging affording an equal degree of protection, to any AUTHORIZED SERVICE CENTER. FUNAI CORP. will not reimburse you for any service done by unauthorized service providers without prior written approval.

To locate your nearest AUTHORIZED SERVICE CENTER or for general service inquiries, please contact us at :

FUNAI CORPORATION
Customer Service

Tel : 1-800-968-3429

<http://www.SylvaniaConsumerElectronics.com>

19900 Van Ness Avenue, Torrance, CA 90501

EMN21887

Printed in China
L2605UF* * * * *

IMPORTANT SAFEGUARDS

WARNING:

TO REDUCE THE RISK OF FIRE OR ELECTRIC SHOCK, DO NOT EXPOSE THIS APPLIANCE TO RAIN OR MOISTURE.



CAUTION: TO REDUCE THE RISK OF ELECTRIC SHOCK, DO NOT REMOVE COVER (OR BACK) NO USER SERVICEABLE PARTS INSIDE. REFER SERVICING TO QUALIFIED SERVICE PERSONNEL.

The important note is located on the rear of the cabinet.

1. **READ INSTRUCTIONS** - All the safety and operating instructions should be read before the appliance is operated.
2. **RETAIN INSTRUCTIONS** - The safety and operating instructions should be retained for future reference.
3. **HEED WARNINGS** - All warnings on the appliance and in the operating instructions should be adhered to.
4. **FOLLOW INSTRUCTIONS** - All operating and use instructions should be followed.
5. **CLEANING** - Unplug TV from the wall outlet before cleaning. Do not use liquid cleaners or aerosol cleaners. Use a damp cloth for cleaning.
EXCEPTION: A product that is meant for uninterrupted service and, that for some specific reason, such as the possibility of the loss of an authorization code for a CATV converter, is not intended to be unplugged by the user for cleaning or any other purpose, may exclude the reference to unplugging the appliance in the cleaning description otherwise required in item 5.
6. **ATTACHMENTS** - Do not use attachments not recommended by the TV manufacturer as they may cause hazards.
7. **WATER AND MOISTURE** - Do not use this TV near water, for example, near a bath tub, wash bowl, kitchen sink, or laundry tub, in a wet basement, or near a swimming pool, and the like.
8. **ACCESSORIES** - Do not place this TV on an unstable cart, stand, tripod, bracket, or table. The TV may fall, causing serious injury to someone, and serious damage to the appliance. Use only with a cart, stand, tripod, bracket, or table recommended by the manufacturer, or sold with the TV.
Any mounting of the appliance should follow the manufacturer's instructions and should use a mounting accessory recommended by the manufacturer. An appliance and cart combination should be moved with care. Quick stops, excessive force, and uneven surfaces may cause the appliance and cart combination to overturn.

THIS SYMBOL INDICATES THAT DANGEROUS VOLTAGE CONSTITUTING A RISK OF ELECTRIC SHOCK IS PRESENT WITHIN THIS UNIT.

THIS SYMBOL INDICATES THAT THERE ARE IMPORTANT OPERATING AND MAINTENANCE INSTRUCTIONS IN THE LITERATURE ACCOMPANYING THE APPLIANCE.

AMEUBLES - Cet appareil ne doit être placé que sur un meuble (avec ou sans roulettes) recommandé par le fabricant. Si vous l'installez sur un meuble à roulettes, déplacez les deux ensembles avec précaution. Un arrêt brusque, l'utilisation d'une force excessive et des surfaces irrégulières risquent de déstabiliser l'ensemble et de le renverser.

9. **VENTILATION** - Slots and openings in the cabinet and the back or bottom are provided for ventilation and to ensure reliable operation of the TV and to protect it from overheating, these openings must not be blocked or covered. The openings should never be blocked by placing the TV on a bed, sofa, rug, or other similar surface. This TV should never be placed near or over a radiator or heat register. This TV should not be placed in a built-in installation such as a bookcase or rack unless proper ventilation is provided or the manufacturer's instructions have been adhered to.

10. **POWER SOURCES** - This TV should be operated only from the type of power source indicated on the marking label. If you are not sure of the type of power supply to your home, consult your appliance dealer or local power company. For TV's intended to operate from battery power, or other sources, refer to the operating instructions.

11. **GROUNDING OR POLARIZATION** - This TV is equipped with a polarized alternating-current line plug (a plug having one blade wider than the other). This plug will fit into the power outlet only one way. This is a safety feature. If you are unable to insert the plug fully into the outlet, try reversing the plug. If the plug should still fail to fit, contact your electrician to replace your obsolete outlet. Do not defeat the safety purpose of the polarized plug.

12. **POWER-CORD PROTECTION** - Power-supply cords should be routed so that they are not likely to be walked on or pinched by items placed upon or against them, paying particular attention to cords at plugs, convenience receptacles, and the point where they exit from the appliance.

13. **OUTDOOR ANTENNA GROUNDING** - If an outside antenna or cable system is connected to the TV, be sure the antenna or cable system is grounded so as to provide some protection against voltage surges and built-up static charges. Article 810 of the National Electrical Code, ANSI/NFPA No. 70, provides information with respect to proper grounding of the mast and supporting structure, grounding of the lead-in wire to an antenna discharge unit, size of grounding conductors, location of antenna-discharge unit, connection to grounding electrodes, and requirements for the grounding electrode. (Fig. A)
14. **LIGHTNING** - For added protection for this TV receiver during a lightning storm, or when it is left unattended and unused for long periods of time, unplug it from the wall outlet and disconnect the antenna or cable system. This will prevent damage to the TV due to lightning and power-line surges.
15. **POWER LINES** - An outside antenna system should not be located in the vicinity of overhead power lines or other electric light of power circuits, or where it can fall into such power lines or circuits. When installing an outside antenna system, extreme care should be taken to keep from touching such power lines or circuits as contact with them might be fatal.
16. **OVERLOADING** - Do not overload wall outlets and extension cords as this can result in a risk of fire or electric shock.
17. **OBJECT AND LIQUID ENTRY** - Never push objects of any kind into this TV through openings as they may touch dangerous voltage points or short out parts that could result in a fire or electric shock. Never spill liquid of any kind on the TV.
18. **SERVICING** - Do not attempt to service this TV yourself as opening or removing covers may expose you to dangerous voltage or other hazards. Refer all servicing to qualified service personnel.
19. **DAMAGE REQUIRING SERVICE** - Unplug this TV from the wall outlet and refer servicing to qualified service personnel under the following conditions:
 - a. When the power supply cord or plug is damaged or frayed.
 - b. If liquid has been spilled, or objects have fallen into the TV.
 - c. If the TV has been exposed to rain or water.
 - d. If the TV does not operate normally by following the operating instructions. Adjust only those controls that are covered by the operating instructions, as improper adjustment of other controls may result in damage and will often require extensive work by a qualified technician to restore the TV to its normal operation.
 - e. If the TV has been dropped or damaged in any way.
 - f. When the TV exhibits a distinct change in performance, this indicates a need for service.
20. **REPLACEMENT PARTS** - When replacement parts are required, be sure the service technician uses replacement parts specified by the manufacturer that have the same characteristics as the original part. Unauthorized substitutions may result in fire, electric shock, injury to persons or other hazards.
21. **SAFETY CHECK** - Upon completion of any service or repairs to this TV, ask the service technician to perform routine safety checks to determine that the TV is in proper operating condition.
22. **HEAT** - This TV product should be situated away from heat sources such as radiators, heat registers, stoves, or other products (including amplifiers) that produce heat.

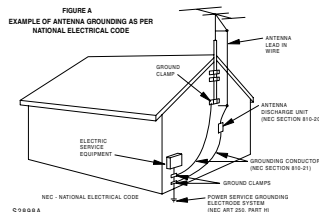

FCC WARNING - This equipment may generate or use radio frequency energy. Changes or modifications to this equipment may cause harmful interference unless the modifications are expressly approved in the instruction manual. The user could lose the authority to operate this equipment if an unauthorized change or modification is made.

Note to CATV system installer: This reminder is provided to call the CATV system installer's attention to Article 820-4.6 of the NEC that provides guidelines for proper grounding and, in particular, specifies that the cable ground shall be connected to the grounding system of the building as close to the point of cable entry as practical.

PREPARATION FOR USE

UNPACKING

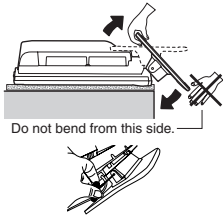

The stand of this TV is folded when you purchased. Place this TV face-down on a flat surface covered with the soft cloth. Bend the stand slowly to forward until it clicks.

If you want to fold the stand again, insert a thin rod into the hole in the right side of the stand as illustrated, bend the stand backward while you keep pushing the hole.

CONNECTIONS

Plug the incoming cable into the ANT jack on the rear of the TV.

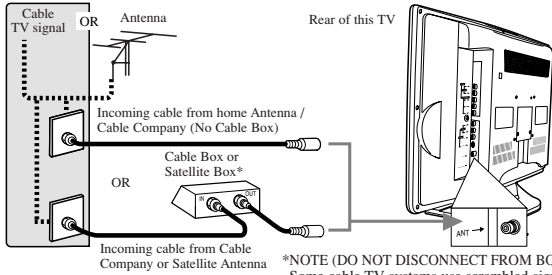

*NOTE (DO NOT DISCONNECT FROM BOX)
Some cable TV systems use scrambled signals and require a special converter to receive these channels. Consult your local cable company.

CAUTION: TO PREVENT ELECTRIC SHOCK, MATCH WIDE BLADE OF PLUG TO WIDE SLOT, FULLY INSERT.
ATTENTION: POUR ÉVITER LES CHOC ÉLECTRIQUES, INTRODUIRE LA LAME LA PLUS LARGE DE LA FICHE DANS LA BORNE CORRESPONDANTE DE LA PRISE ET POUSSER JUSQU'AU FOND.

Note:

- For your safety and to avoid damages to the unit, unplug the antenna cable from the ANT jack before moving the unit.

[EXTERNAL CONNECTION]

VIDEO1 input

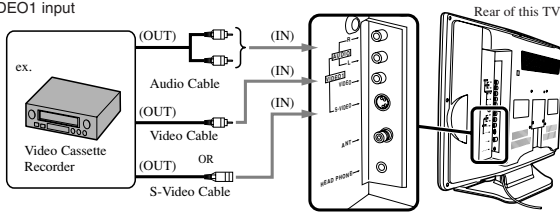

Notes:

- The AUDIO L jack is for mono input. The sound is heard from both speakers. Use this jack for connecting monaural audio equipment.
- The S-VIDEO jack is given priority over the VIDEO jack.

VIDEO2 input

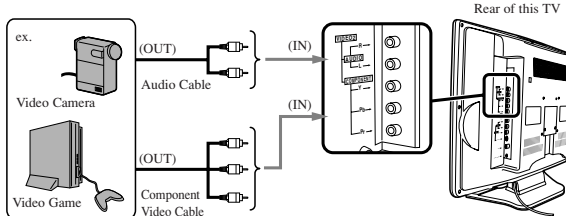

Notes:

- This TV can accept 480p / 480i / simplified 1080i video signal.
- Simplified 1080i video signal differs to the original 1080i video signal because it is displayed after converted into 480p signal.

INSTALLING THE BATTERIES

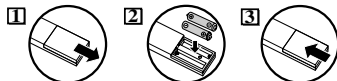

Install two AAA batteries (supplied) matching the polarity indicated inside battery compartment of the remote control.

[BATTERY PRECAUTIONS]

- Be sure to follow the correct polarity as indicated in the battery compartment. Reversed batteries may cause damage to the device.
- Do not mix different types of batteries together (e.g. Alkaline and Carbon-Zinc) or old batteries with fresh ones.
- If the device is not to be used for a long period of time, remove the batteries to prevent damage or injury from possible battery leakage.
- Do not try to recharge batteries not intended to be recharged; they can overheat and rupture.

INITIAL SETUP

When you turn on the power for the first time, the "SELECT LANGUAGE" menu is displayed. The "INITIAL SETUP" menu is displayed every time you turn on the unit unless the scanning is completed.

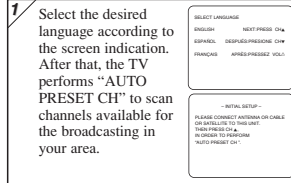

2 If the TV screen shows snow noise and there is no operation for more than 5 seconds, "HELPFUL HINTS" appears. Follow the instructions listed on-screen.

When the scanning is completed, or [MENU] is pressed during channel scanning to cancel it, the tuner stops on the lowest memorized channel.

Notes:

- In case no channel can be received by the channel scanning, "NO TV SIGNALS" is displayed on the screen. Turn off the unit and check the antenna connection, then follow step 1 again.
- If those settings do not work properly, please call our help line on the front page of this owner's manual.

SELECTING AUDIO/VIDEO INPUT

When you use the AUDIO/VIDEO input jacks, select "VIDEO1" or "VIDEO2" mode by pressing [INPUT SELECT] on the remote control or [SELECT] on the main unit. The input mode changes by pressing the button as following:

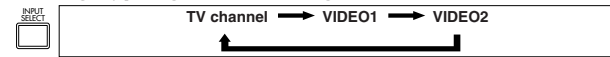

TILT STAND

Tilt Stand

Adjust the stand to change the angle of TV (-5° ~ 10°).

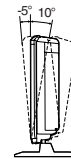

OPERATIONS

REMOTE CONTROL AND TOP PANEL FUNCTION

IR transmitter
To send infrared ray (IR) signal

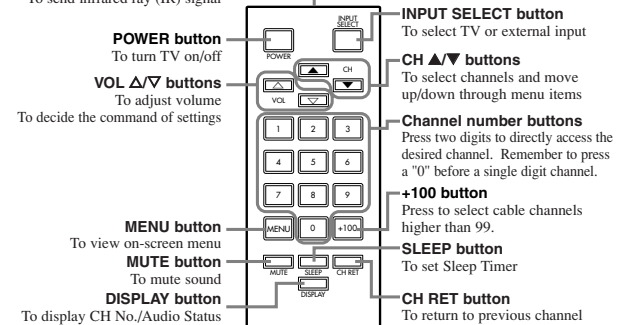

Note:

- You can test if the remote control sends out the infrared signal with an AM radio. (Refer to "TROUBLESHOOTING GUIDE".)

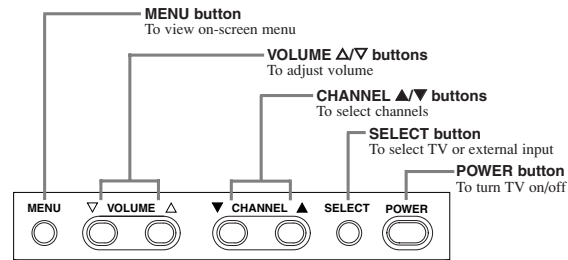

Note:

- If some digits appear in the corner of the screen when the unit is turned on at the first time, press [POWER] without unplugging the power cord.

OPERATIONS (Continued)

CHANNEL SETTING

[AUTO PRESET CHANNELS]

Channel presetting is necessary at the start or in case you moved the TV to a different area. This feature automatically scans and memorizes all available channels in your area and lets you easily select with [CH ▲/▼].

- Select "CHANNEL SET UP"
- Select "AUTO PRESET CH"

The tuner starts scanning automatically.
- After scanning (completed)

The lowest memorized channel appears. OR (in failure) Check antenna connection and try again.

Note:

- The TV may recognize TV channels as CATV channels if reception condition is poor. If this happens, check the antenna connections and try scanning again when reception conditions are better.

SLEEP TIMER SETTING

- Select "SLEEP"

The time increases by 10 minutes up to 90.

[ADDING/DELETING CHANNELS]

You can add channels that was not memorized by AUTO PRESET CH due to the bad reception status and also delete channels you no longer receive or seldom watch.

- Select "CHANNEL SET UP"
- Select "ADD/DELETE CH"
- Select the channel you wish
- Add or delete the channel

Add: light blue
Delete: light red
- To exit the menu

Notes:

- When you disconnect the unit from the AC outlet or when you have a power failure, the sleep time will be lost.
- To cancel the sleep timer, press [SLEEP] repeatedly until "SLEEP 0 MINUTE" is displayed.
- The Sleep Timer Setting display will disappear automatically after 10 seconds of the operation.
- You can also set the Sleep Timer by pressing [SLEEP] repeatedly.

MULTI-CHANNEL TELEVISION SOUND (MTS) SYSTEM

- Select "TV SOUND"
- Select the desired sound mode
- To exit the menu

Menu selection	MAIN	MONO	SAP*
Regular broadcast	-None-	-None-	-None-
Stereo broadcast	STEREO	MONO	STEREO
SAP	MAIN	MAIN	SAP

***Second Audio Program (SAP) :**
Your program can also be received in a second language or sometimes a radio station.

Note:

- If you select [SAP] when second audio is not available, the TV will receive normal audio.

PICTURE ADJUSTMENT

- Select "PICTURE"
- Select an item to adjust
- Adjust the setting

BRIGHTNESS
Adjust until the darkest parts of the picture are as bright as you prefer.
[-] : decrease brightness
[+] : increase brightness

CONTRAST
Adjust to increase or decrease contrast.
[-] : decrease contrast
[+] : increase contrast

COLOR
Adjust to be brilliant or pale color.
[-] : be pale color
[+] : be brilliant color

TINT
Adjust to obtain natural skin tones.
[-] : add red
[+] : add green

SHARPNESS
Adjust the detail of the picture.
[-] : less clear
[+] : more clearer

Note:

- The display will disappear automatically after 10 seconds unless you press any buttons.

BACK LIGHT SETTING

- Select "BACK LIGHT"
- Select the desired brightness mode
- To exit the menu

CLOSED CAPTION

You may view specially labeled (cc) TV programs, movies, news and prerecorded tapes, etc. with either a dialogue caption or text display added to the program.

- Select "CAPTION"
- Select the desired caption mode
- To exit the menu

[CAPTION MODE (CAPTION1, CAPTION2)]

- CAPTION1**
displays standard closed captions (what a character is saying).
- CAPTION2**
displays foreign language closed captions (foreign language words showing what a character is saying).
- There are three ways of displaying according to programs:
Paint-on mode : Displays input characters on the screen immediately.
Pop-on mode : Once characters are stored in memory, they are displayed all at once.
Roll-up mode : Displays the characters continuously by scrolling (max. 4 lines).

[TEXT MODE (TEXT1, TEXT2)]

- TEXT1** and **TEXT2**
display half-screen text by scrolling (such as a channel guide, schedule or announcement).

Notes:

- If closed captioning is not broadcasted, you cannot receive it and nothing is displayed.
- When your TV receives a special effects playback signal (i.e., Search, Slow and Still) from a VCR's video output channel (CH3 or CH4), the TV may not display the correct caption or text.
- Captions and texts may not match the TV voice exactly.
- Interference may cause the closed caption system not to function properly.
- The caption or text characters will not be displayed while the menu display or functions display is shown.
- If a black box appears on the screen, this means that the TV is set to TEXT mode. To clear screen, select [CAPTION1], [CAPTION2] or [OFF].

OPTIONAL SETTINGS

LANGUAGE SELECTION

- Select "LANGUAGE"
- Select the desired language
- To exit the menu

OPTIONAL SETTINGS (Continued)

V-CHIP SET UP

This enables parents to prevent their children from watching inappropriate material on TV.

- The limitation is not available for news, sports programs, unedited movies on premium cable channels and Emergency Broadcast System signals.
- When you try to access to a program which is blocked, "PROTECTED PROGRAM by ..." message appears on the TV screen.
- Programming may be rated by the Motion Picture Association of America (MPAA) or according to the Television Parental Guidelines. In order to block any inappropriate programming, set your limits in both MPAA RATING and TV RATING.

1 Select "V-CHIP SET UP"

2 Enter 4-digit code

If you have not set up your personal access code, enter 0000 (default access code).

3 Select a feature to set up

A [TV RATING SET UP]

4 Select a rating

<Selection> <Rating Category Explanations>

- TV-Y : Appropriate for all children
- TV-Y7 : Appropriate for children seven and older
- TV-G : General Audience
- TV-PG : Parental Guidance suggested
- TV-14 : Unsuitable for children under 14
- TV-MA : Mature audience only

5-1 * Rating with no sub categories
Set to [BLOCK] or [VIEW]

5-2 * Rating with sub categories

Set to [BLOCK] or [VIEW]

<Selection> <Rating Category Explanations>

- TV-Y7 : Fantasy Violence
- TV-PG / TV-14 / TV-MA : Suggestive Dialog (TV-PG, TV-14 only)
- L : Coarse Language
- S : Sexual Situation
- V : Violence

B [MPAA RATING SET UP]

4 Select a rating

5 Set to [BLOCK] or [VIEW] repeatedly

<Selection> <Rating Category Explanations>

- G : General Audience
- PG : Parental Guidance suggested
- PG-13 : Unsuitable for children under 13
- R : Restricted; under 17 requires accompanying parent or adult guardian
- NC-17 : No one under 17 admitted
- X : Mature audience only

6 To exit the menu

Notes (for TV RATING and MPAA RATING):

- You cannot access the setup menu when the "PROTECTED PROGRAM by ..." message appears. Move to an unblocked channel before you press [MENU].
- When you select a rating and set it to [BLOCK], the higher ratings will be blocked automatically. The lower ratings will be available for viewing.
- When you set the lowest rating to [VIEW], all other ratings will automatically be available for viewing.

C [CHANGING THE ACCESS CODE]

4 Enter 4-digit code

5 To exit the menu

Notes:

- Make sure you enter exactly the same new code in the "CONFIRM CODE" space as one in the "NEW CODE" space. If they are different, the "NEW CODE" space is cleared for redoing.
- Your personal access code will be erased and will return to the default (0000) when a power failure occurs or when you turn off the power using a wall switch. If you have forgotten the code, unplug the power cord for 10 seconds to restore the access code to 0000.

TROUBLESHOOTING GUIDE

Sometimes a performance problem can be easily solved by checking seemingly apparent but often overlooked possibilities. Before arranging for service, check these items. It could save your time and money.

POSSIBLE REMEDY	PROBLEM													
	Remote Control Doesn't Work	Blank Screen	Picture Distorted	Picture Rolls Vertically	No Color	Poor Reception on Some Channels	Weak Picture	Lines or Spots in Picture	Ghosting Picture	Picture Blurred	Sound OK, Picture Poor	No Picture or Sound	Different Color Marks on Screen	Black or Luminous Spot on Screen
Try a new channel, if OK, then possible station trouble.														
Is TV plugged in? Power at outlet?	X													
Is TV's power on? Is antenna or cable connected to terminal on the back of the set? If outside antenna is being used, check for broken wire or loose connection. Check for local interference.		X	X	X	X	X	X	X	X	X	X	X	X	X
Turn off the TV and then turn it on after about a minute. Adjust COLOR control. Adjust CONTRAST & BRIGHTNESS control.					X									
Check batteries in remote control. Move the TV away from the nearby appliances which generate a magnetic field. Turn off using [POWER], then turn it on again 30 minutes later or so. Temperature around is too low.	X													
Life of the Back Light is approximately 50,000 hours. Ask the Service Center to replace. It is quality of the LCD Panel. Check if there is an obstacle between the sensor and the remote control.		X	X	X	X	X	X	X	X	X	X	X	X	X
Test the signal output.* If OK, then possible remote sensor trouble.	X													

Closed Caption Problem	Possible Remedy
Misspelled captions are shown.	Spelling errors may pass through uncorrected by the closed captioning production company in a live broadcast.
Text is not shown in its entirety or there is a delay of what is being said.	Captions that are delayed a few seconds behind the actual dialogue are common for live broadcasts. Most captioning production companies can display a dialogue to a maximum of 220 words per minute. If a dialogue exceeds that rate, selective editing is used to insure that the captions remain up-to-date with the current TV screen dialogue.
Captions are scrambled with white boxes on the TV screen.	Interference caused by building, power lines, thunderstorms, etc. may cause scrambled or incomplete captions to appear.
No captions are displayed in a program which must contain closed caption.	Broadcasters may use a time compression process to the actual program so that additional advertising time can be given. In this case, captions will be lost since the decoder cannot read the compressed information.
No captions are displayed when playing a prerecorded videotape with closed caption.	The videotape may be either an illegal copy or the tape duplicating company may accidentally have left out the captioning signals during the copying process.
The TV screen shows a black box.	You are in TEXT mode. Select [CAPTION1], [CAPTION2] or [OFF].

The LCD panel is manufactured to provide many years of useful life. Occasionally a few non active pixels may appear as a fixed point of blue, green or red. This is not to be considered a defect in the LCD screen.

MAINTENANCE

CABINET CLEANING

- Wipe the front panel and other exterior surfaces of the TV with a soft cloth immersed in lukewarm water and wrung dry.
- Never use a solvent or alcohol. Do not spray insecticide liquid near the TV. Such chemicals may cause damage and discoloration to the exposed surfaces.

PICTURE SCREEN CLEANING

If the liquid crystal display panel should require cleaning, wipe it with a cotton or soft cloth. Before cleaning the picture screen, disconnect the power cord.

SUPPLIED ACCESSORIES

- Owner's Manual (1EMN21887)
- Remote control unit (NE900UD)
- Batteries ("AAA" x 2)

SPECIFICATIONS

GENERAL SPECIFICATIONS

Television system: NTSC-M
TV Standard

Closed Caption System: \$15.119/FCC

Channel coverage

- VHF: 2 ~ 13
- UHF: 14 ~ 69
- CATV: 2 ~ 13, A ~ W, W+1 ~ W+84, A-5 ~ A-1, 5A

Tuning System: 181 channels frequency synthesized tuning system

Channel access: Direct access keyboard, programmable scan and up/down

Terminals

- Antenna input: VHF/UHF/CATV 75 ohm unbalanced (F-type)
- S-Video input: Mini DIN 4-pin jack
- Video input: RCA connector x 1
- Audio input: RCA connector x 4
- Component video input: One pin jack (Y), 1Vpp(75 ohm) Two pin jacks (Pr)(Pb), 700mVpp(75 ohm)
- Headphone: 1/8" stereo (3.5mm)

Stereo Sound System

- 2 speakers
- 2 ways AV input

ELECTRICAL SPECIFICATIONS

Sound output: 1W, 8 ohm x 2

OTHER SPECIFICATIONS

Remote control: Digital encoded infrared light system

Operating temperature: 5°C to 40°C (41°F~104°F)

Power requirements: AC120V, 60Hz

Power consumption (Maximum): 53W

LCD: 20"

Dimensions (H x W x D): With Tilt Stand 18-5/16" x 23-3/8" x 9-1/8" (465mm x 594mm x 231mm)

Weight: With Tilt Stand: 11.0 lbs. (5.0kg)

• Designs and specifications are subject to change without notice and without our legal obligation.

• If there is a discrepancy between languages, the default language will be English.